

25 Watt — PLD25W-56-C1300-RP REV 1.2

Flicker-Free, Deep Dimming, PC & RSET Programmable.

Constant Current LED Driver with 0-10V & PWM Dimming, with Auxiliary Output 12V/200mA

Class 2 Isolated Dimming US & CN, LED Driver Class 2 UL Class P

PLD driver is a high-performance LED driver that provides smooth, continuous <1% dimming (until off) for virtually any LED fixture, whether it requires constant current or constant voltage. It is the most versatile LED driver offered today due to its compatibility with a wide variety of LED arrays, multiple form factors, and numerous control options.

Module Temperature Protection (MTP) supports thermal feedback and robust thermal manage. LED module working temperature can automatically be reduced by the PLD driver, setting by software of the output current decrease depending on the measured NTC value to avoid decreased lifetime of the LED module.

LED codes configure dimming curve, LED current and more. Programmable solution that offer ultimate design flexibility. GUI & RSET interface for programmable output current. Flexibility & SKU reduction for OEM.

Key Features

- Drive Mode: Flicker-Free Programmable Constant Current.
- Technology: Active PFC 2-Stage Switch Mode.
- Input Voltage: 120 to 277 Vac, 50/60Hz.
- Output Power: 25 Watt Max.
- Dimming: Smooth & Continuous Deep Dimming from 0% to 100%. LEDs turn on to any dimmed level without going to full brightness. Constant Current Reduction (CCR) dimming methods.
- 0-10V / PWM: 2-wire Analog / Digital Control Dimming (Isolated, Class 2).
- Output Voltage: 12Vdc to 56Vdc.
- Output Current: 150mA to 1300mA (Set by resistor value Rset or GUI).
- Efficiency: Up to 85%.
- Warranty: 5 years.

Special Features

- Continuous, flicker-free dimming from 100% to 1%, dim-to-off programmable, Minimum dimming programmable, Dimming curve programmable (Optional: linear, log).
- Dimming control is isolated for AC input and DC output.
- Programmable options: Output Current Soft-Start, Constant Lumen Output, End-of-life Indicator.
- Output current can be set by an GUI and an external NTC.
- Safety isolation between primary and secondary.
- A rated lifetime of 50,000 hours @ Tc = 80 °C.
- Safety: UL8750, UL1310 Class 2, CSA22.2.
- EMC: FCC 47CFR Part 15 Class A.
- Inrush Current Limiting Circuitry: AC Power Line: line to line 4 Kv/2KA 8/20µs, line to earth 6 Kv/0.5KA 8/20µs.
- Metal case. Meet the RoHs directive.
- IP20, NEMA1 compliant for Dry & Damp Locations.
- 100% performance tested with CHROMA 8000 system at YG factory.
- 100% burned in with program-control test system at YG factory, at 50 degrees ambient temperature.

Main Electrical Specification

Output Power (W)	Output Voltage (V)	Output Current (mA)	Efficiency @ Max Load			Case Temp. Max °C	Input Current (A)			Max. Input Power	THD (%) @ Max Load	Weight (Kgs)	Envir. Protection Rating
			@120V	@230V	@277V		@120V	@230V	@277V				
25	12 - 56	150 - 1300	84	85	83	90	0.29	0.16	0.14	30	20	0.42	UL Dry & Damp Location

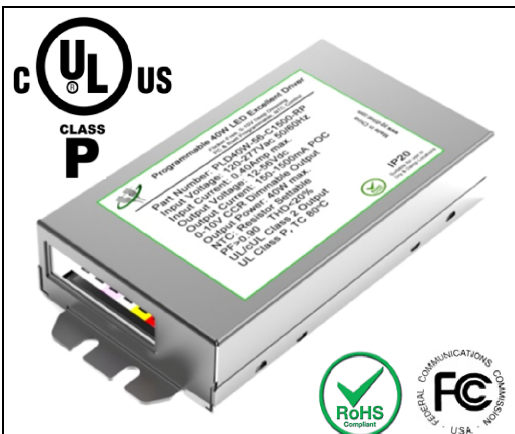

Notice of use:

1. The DIM+ line can't touch the LED+ line and AC line.
2. LED- cannot be shorted with the DIM-.

Size	Unit	Inch	Millimeter
Case Length		4.96	126.00
Case Width		2.41	61.20
Case Height		0.95	24.00
Mounting Length		4.57	116.00
Connectors		WAGO-253 Push Pin or equivalent	

LED wiring distance

Recommended maximum wiring distance at full load.

AWG	#20	#19	#18	#17	#16
Distance (m)	14	18	22	28	36
Distance (ft)	45.9	59	72.2	91.9	118.1

WAGO-253 CONNECTORS

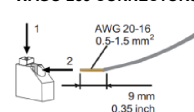



Programmable 25W LED Excellent Drivers

Sino-US joint venture

Programmable Parameters

Programmable Parameter	Programmable Minimum Value	Programmable Maximum Value	Factory Default	GUI Programmable	Notes / Conditions	
Output Constant Current (Iout)	150 mA	1300 mA	700 mA	YES	RSET Programmable	
Disable Dimming	NO	YES	NO	YES	N/A	
Dimming Curve	LINEAR	0%	N/A Fixed 100%	0%	YES	N/A
	LOG	0%	N/A Fixed 100%	0%	YES	N/A
NTC Minimum Ohms	1KΩ	10KΩ	2KΩ	YES	N/A	
NTC Minimum %out	~0%	100%	~10%	YES	N/A	
NTC Maximum Ohms	2KΩ	10KΩ	6.3KΩ	YES	N/A	
Output Current Soft-Start	N/A	N/A	OFF	YES	N/A	
Constant Lumen Output	N/A	N/A	OFF	YES	N/A	
End-of-life Indicator	N/A	N/A	OFF	YES	N/A	

Input Specifications

Parameter	Min.	Typ.	Max.	Notes / Conditions
Input Voltage	108 Vac	---	305 Vac	120, 230, 240, 277 Vac Nominal Values
Input Frequency	47 Hz	50/60 Hz	63 Hz	50/60 Hz Nominal
Input AC Current	---	---	0.29 A	Measured at 120 Vac / 60Hz Input, Output Full Load
	---	---	0.16 A	Measured at 230 Vac / 50Hz Input, Output Full Load
	---	---	0.14 A	Measured at 277 Vac / 60Hz Input, Output Full Load
Inrush Current (Peak)	---	30 A / 1.8uS	33 A / 2uS	Measured at 120 Vac / 60Hz Input, Output Full Load
	---	55 A / 1.8uS	60 A / 2uS	Measured at 277 Vac / 60Hz Input, Output Full Load
Leakage Current	---	300 μA	350 μA	Measured at 120 Vac / 60Hz Input, Output Full Load
	---	700 μA	750 μA	Measured at 277 Vac / 60Hz Input, Output Full Load
THD	---	---	20%	Measured at 120, 230, 277 Vac Input, Output ≥ 33% Load The working window that meets the DLC standard sees the curve on page 5.
Power Factor (PF)	0.90	---	---	

Output Specifications

Parameter	Min.	Typ.	Max.	Notes / Conditions
DC Output Voltage	12V	---	56V	The maximum output current is 1500mA, the output voltage at 56V.
Output Voltage (max.)	---	---	59V	Measured at 120-277 Vac / 60Hz Input, Output no Load.
Output Constant Current	150 mA	---	1300 mA	The maximum output voltage is 56V, output current in 1300mA.
Output Power	3W	---	25W	Voltage Foldback, Power operation window see the curve on page 5.
Flickering Index (Vpk-pk)	---	---	3% Vo	Full load. 20MHz BW, Full load output in parallel with 0.1uF & 10uF CAP. Flickering Index is defined as $[(Y_{max}-Y_{min})/(Y_{max}+Y_{min})] * 100\%$. Y may be V or I
Flickering Index (Ipk-pk)	---	---	5% Io	
Line Regulation	-3%	---	+3%	Measured at 120-277 Vac / 60Hz Input, Output Full Load
Load Regulation	-4%	---	+4%	Measured at 120, 230, 277 Vac / 60Hz Input
Start-up Time	---	300 ms	500 ms	Measured at 120 Vac / 60Hz Input, Output Full Load
	---	200 ms	400 ms	Measured at 277 Vac / 60Hz Input, Output Full Load
Output Overshoot	-2%	---	+5%	Measured at 120, 230, 277 Vac Input, When power on or off
Hold-up Time	---	10ms	---	Typical @ 277 Vac Input, Output Full Load

Protection Specifications

Address: No. 575, 9F Gushu Road, Bao'an District, Shenzhen, Guangdong Province, China
 Phone: +86 755 27850656, +86 13501598118 Mr. Wu Fax: +85 755 23289631
 +86 755 27850525, +86 13602603460 Miss joy
 Email: wgm@yg-driver.com Skype: yg-wgm

Product Release Date: 2017.03
 Product Updates Date: 2019.11.08

Web: www.yg-driver.com



Programmable 25W LED Excellent Drivers

Sino-US joint venture

Parameter	Min.	Typ.	Max.	Notes / Conditions
Output Short Circuit (SCP)	---	---	---	No Damage. Auto recovery after short is removed.
Output Over Current (OCP)	---	---	+8% I _o	Constant Current Limiting circuit.
Output Over Voltage (OVP)	---	---	120% V _o	No Damage. Auto recovery after short is removed.
Output Power Limit (OPL)	---	---	25W	Voltage Foldback.
Temperature Protection (OTP)	95°C		110°C	At T _c from 95 to 110, the output current decreases linearly from maximum to zero.

Dimming Specifications

Items	Parameter	Min.	Typ.	Max.	Notes / Conditions
12V Auxiliary Output	Output Voltage	10.8 V	12.0 V	13.2 V	Yellow Wire
	Output Current	0 mA	100 mA	200 mA	Yellow Wire
0-10V Dimming	Input Absolute Voltage	-2.0 V	10 V	15 V	Purple Wire
	Output Source Current	0.1 mA	1.2 mA	2.0 mA	Purple Wire
	Output Current Range in 0-10V Dimming	0%	---	100%	CCR output
	Output Current in 0-10V Pin Open	---	Normal	---	It's a constant current output with active PFC.
	Output Current in 0-10V Pin Short Circuit	---	0	---	CCR output
PWM Dimming	Input Absolute Voltage	-2.0 V	10 V	15 V	
	Input Current on PWM pin	0.1 mA	1.2 mA	2.0 mA	
	PWM Frequency	200 Hz	---	3 KHz	
	PWM Duty	0 %	---	100%	
	Output Current Range in PWM Dimming	0%	---	100%	CCR output
	Output Current in PWM Pin Open	---	Normal	---	It's a constant current output with active PFC.
	Output Current in PWM Pin Short Circuit	---	0	---	CCR output
0-10V & PWM Dimming	Compatible dimming function: 0-10V and PWM dimming.				

Programmable Specifications

Parameter	Min.	Typ.	Max.	Notes / Conditions
Port				PC_SET
Resistance Value	0 Ω	8.2 KΩ	> 8.2 KΩ	Between RSET and GND.
Setting Output Current	150mA	1300mA	1300mA	The output voltage is automatically limited.
PC_SET Max.		1300mA		Setting Output Current Value, Dimming range is min to 1300mA.
PC_SET Min.		150mA		Setting Output Current Value, It is min.
PC_SET Voltage	0		5V	

NTC Control Specifications

Parameter	Min.	Typ.	Max.	Notes / Conditions
Port				NTC
NTC Resistance Value	0 Ω	15 KΩ	> 15 KΩ	Between NTC and GND. NTC=15 KΩ±2%, B25/85=3700.
Controlling Output Current	150mA	1300mA	1300mA	Max dimming current is limited by NTC.
NTC Open Circuit		1300mA		
NTC Short Circuit		150mA		
NTC Voltage	0		5V	

General Specifications

Parameter	Min.	Typ.	Max.	Notes / Conditions
Cooling		Convection		

MTBF	450,000 hours	For 12V output model, measured at 120 Vac input, 100%Load and Tc=85° C (MIL-HDBK-217F).
Life Time	50,000 hours	

Environmental Specifications

Parameter	Min.	Typ.	Max.	Notes / Conditions
Case Temperature (Tc)	-30 °C	---	+90 °C	Measured at location specified on case.
Operating Temperature (Ta)	-30 °C	---	+55 °C	This is a reference range. Tc controls temperature range.
Storage Temperature (Ts)	-40 °C	---	+100 °C	Non operating temperature range.
Operating Humidity	---	---	90% RH	Relative Humidity. Non-condensing.
Vibration	5 Hz	---	55 Hz	2G, 10 minutes / 1 cycle, period 30 minutes, each along X, Y, Z axis.

Safety Compliance

Safety Category	Standards / Notes
UL / cUL	UL8750, CSA C22.2 NO.250.13, US & CN LED Driver Class 2 , UL CLASS P
Withstand Voltage	Input to Output: 2KV
Output / Dim	2.5KV
Enclosure / Ground - Input & output / NTC & Dim	2.0KV
Isolation Resistance	Input to Output: >10MΩ, 500Vdc @ 25°C, 70% RH
Aux Circuit	Aux is Isolated from AC Input and DC Output.
0-10V Class 2 Isolated Dimming	DIM+ (Purple) / DIM- (Grey) are Class 2 Isolated from AC Input and DC Output.
FG	Input ground. It is a safety ground.

EMC Compliance

EMI Category	Standards
FCC	FCC 47CFR Part 15 Class A, ANSI C63.4: 2009
Energy Star	Energy Star transient protection: Driver shall comply with ANSI/IEEE C62.41.1-2002 and ANSI/IEEE C62.41.2-2002 0.5 μs 100 kHz Ring, 6kV/0.2kA, L-N, L-G, LN-G (10 strikes)
EMS Category	Notes
EN 61000-4-2	Electrostatic Discharge (ESD): 8 kV air discharge, 4 kV contact discharge
EN 61000-4-3	Radio-Frequency Electromagnetic Field Susceptibility Test-RS
EN 61000-4-4	Electrical Fast Transient / Burst-EFT
EN 61000-4-5	Surge Immunity Test: ANSI/IEEE C62.41.2-2002 1.2/50μs and 8/20μs Combination, 4kV/2kA, L-N (10 strikes). 1.2/50μs and 8/20μs Combination, 6kV/0.5kA, L-G, LN-G (10 strikes).
EN 61000-4-6	Conducted Radio Frequency Disturbances Test-CS
EN 61547	Electromagnetic Immunity Requirements Applies To Lighting Equipment

Note: the above test data are in the condition of 25 C ambient temperature, except for the marked temperature.

Typical Applications

- . Constant Current Driver with programmable.

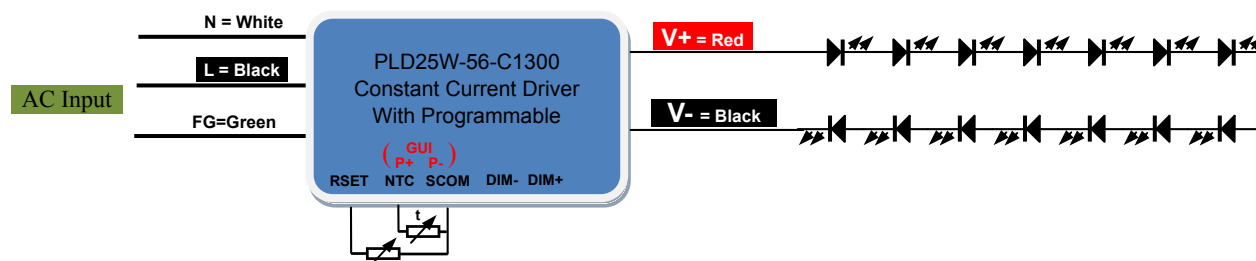

- 0-10V or PWM Dimming Driver with programmable.

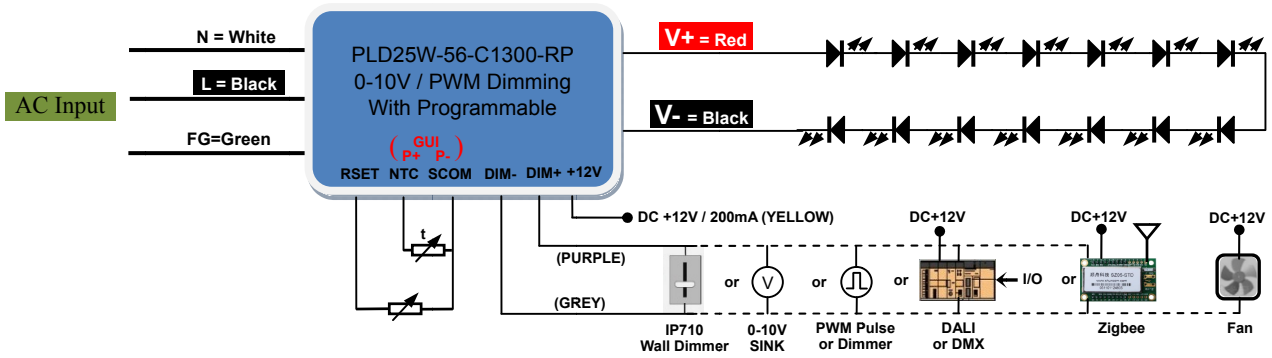

Dimming Curve

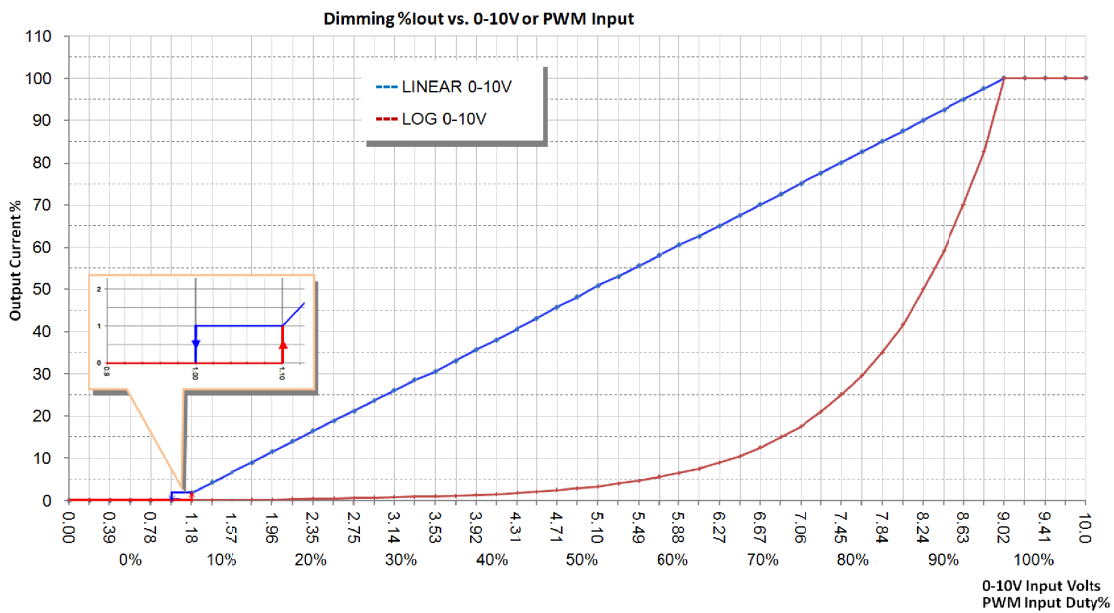

Power Operating Window

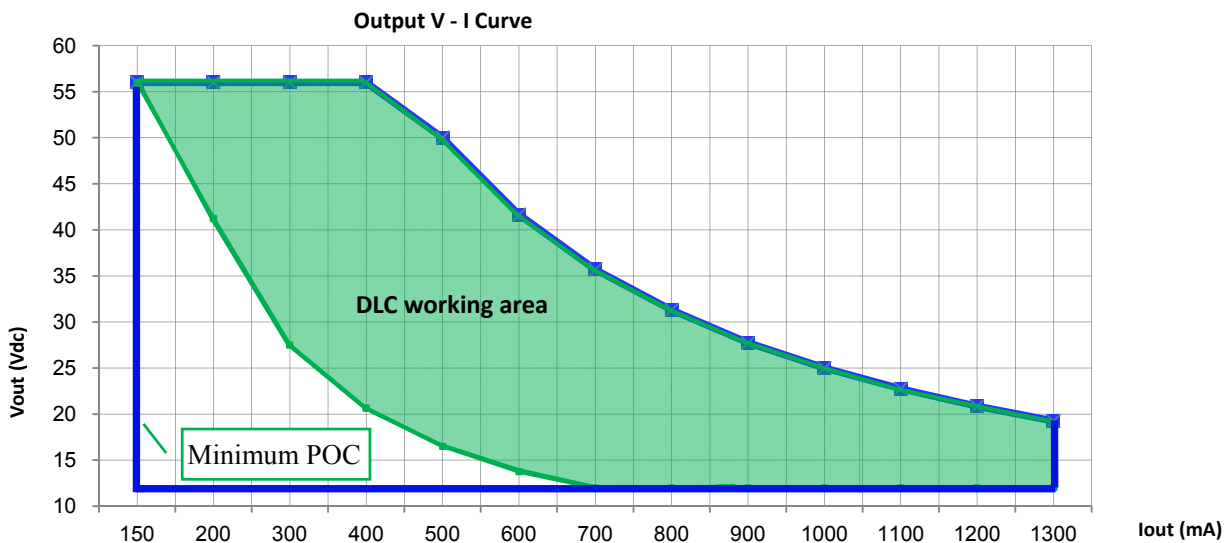

Note: When the output current is set, the output voltage is automatically limited within the curves.

POC (Programmable Output Current)

Set by Resistor Value "RSET" or using YG Programmer USB interface & YG PC based GUI Software.
 Programmable Output Current: 150 – 1300mA. Power limited to 25W maximum by Voltage fold-back.
 When RSET is open (no resistor present) then GUI controls programmed output current.

Factory Default: GUI set to 700mA with RSET Open.

Output Current vs. RSET value is within +/-5%

RSET can be any $\geq 1/4W$, $\pm 1\%$, $\geq 20V$ rated resistor.

RSET (Ω)	Iout (mA)
208	150
346	209
592	308
838	398
1084	478
1330	554
1576	622
1822	687
2068	745
2314	800
2560	853
2806	899
3052	944
3298	985
3544	1024
3790	1062
4036	1095
4282	1128
4528	1158
4774	1187
5020	1215
5266	1242
5512	1266
5758	1282
6000	1300
7000	GUI set

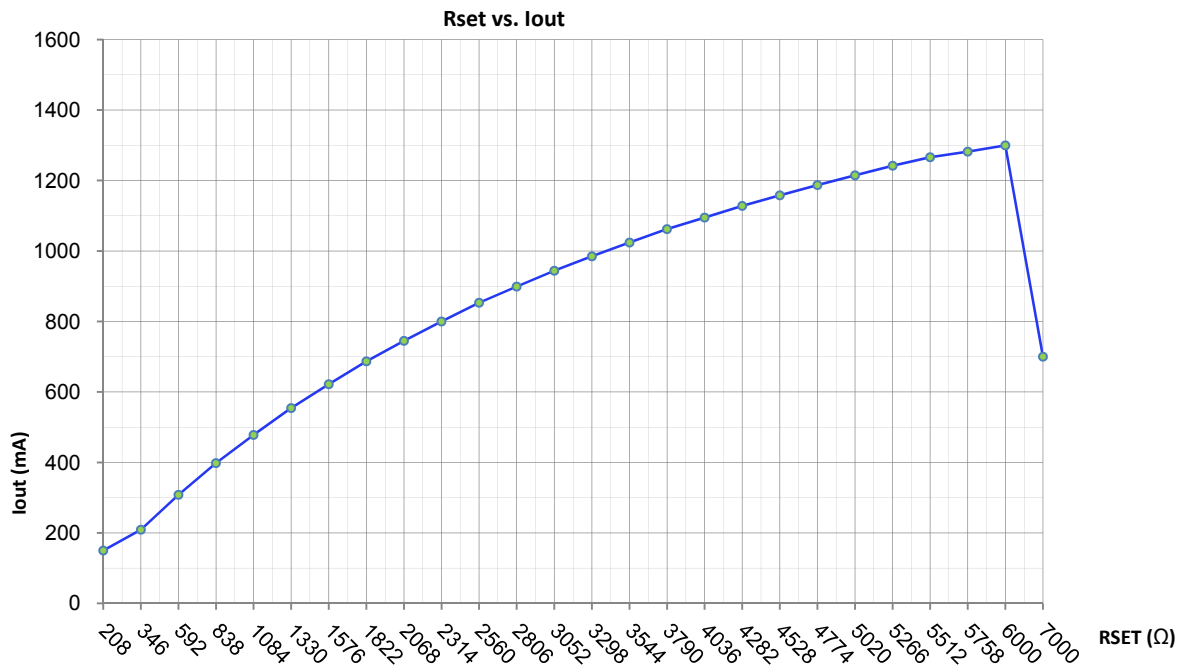

Note: The value of NTC is above 6.2K, NTC does not control the output current.

RSET > 8300 Ohms will default Iout to GUI setting.

NTC Current Control

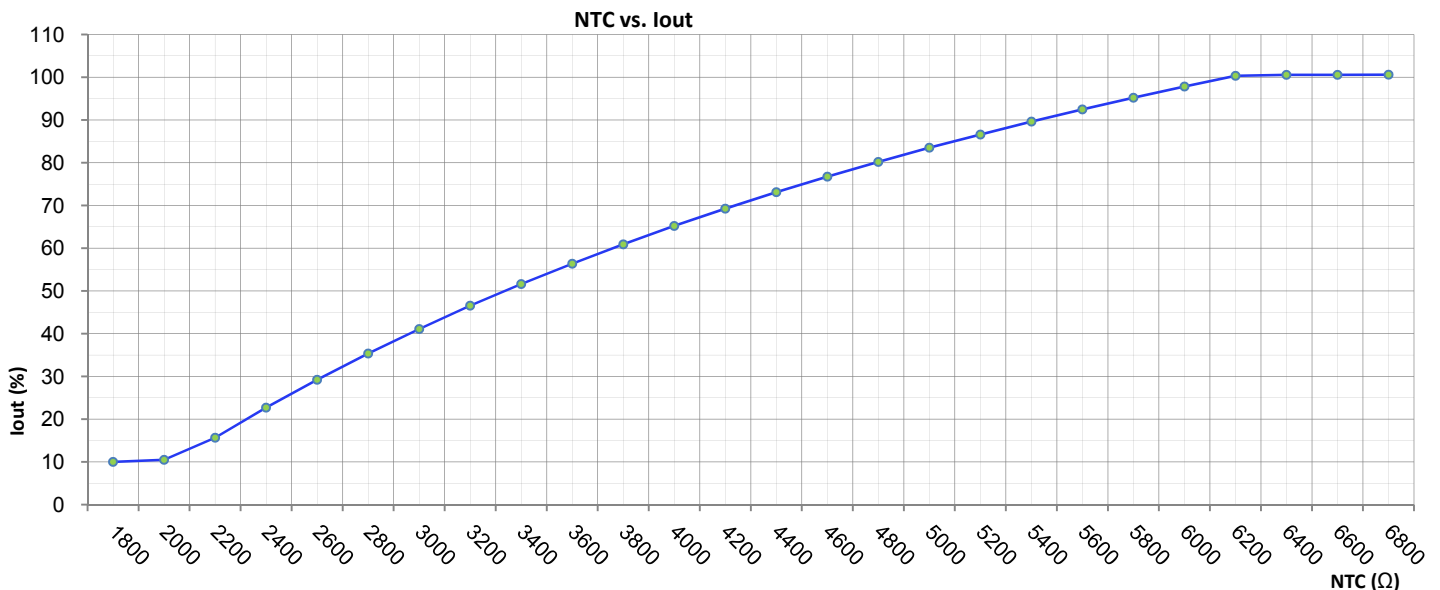

Note: Maximum dimming current is limited by NTC.

NTC values, NTC High, NTC Low and NTC Minimum Iout can be programmed.

Using YG Programmer USB interface & YG PC based GUI Software.

Default: NTC Low = 2.0K ~ 10% Iout, NTC High = 6.3K, 100% Iout.

Module Temperature Protection Example

NTC = 0805SMD, $R_{25C} = 15K \text{ Ohms} \pm 2\%$, $R_{64C} = 3700$, Vishay Part#: NTCS0805E3153GMT

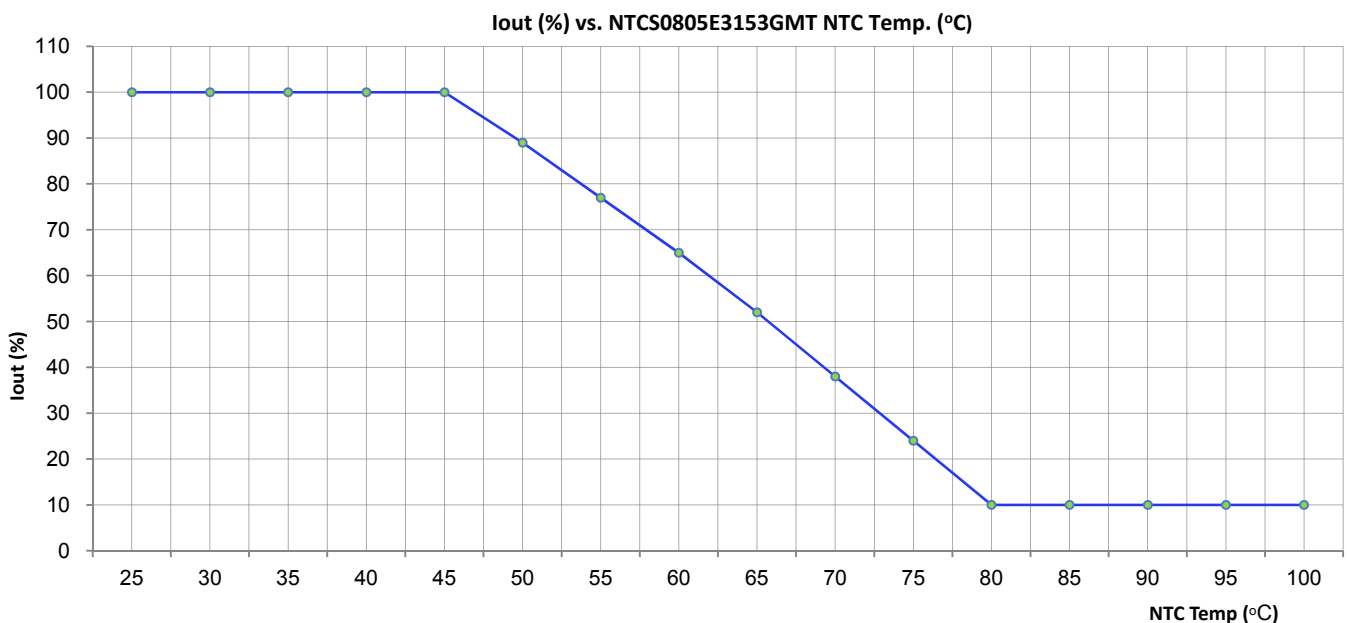

YG Programmer PC Based Software, USB Interface

Programmable Output Current (POC): Programmable Iout from 150mA to 1300mA.

Programmable Minimum Dim Level: 0% (OFF) to 100% Iout programmed value.

Programming Tool:

The YG Programmer is a programming and configuration tool for YG intelligent programmable LED drivers. It consists of the YG programmer which is connected between the USB port of a computer and the LED driver being programmed, and the YG programmer software. The YG programmer software is a PC based graphical user interface that allows the user to program and configure the operating parameters of an YG Programmable LED Driver. This interface allows the operator to set the LED drivers output current within its specified range. In the increments specified. It also provides the ability to enable/disable and control features like "Dimming", "Auxiliary Output", "Constant Lumen Module" & "End-of-life indicator" when available in the YG intelligent LED driver being programmed.

YG Programmer:

Is the physical USB unit connected between the USB port of a computer and the LED driver being programmed?

This unit also provides all power required to the LED driver being programmed. No connection to an AC power source is required for programming the LED driver.

YG Programmer Software:

The YG Programmer software is the windows based GUI that allows the user to assign custom part number(s) to the LED driver being programmed. The user can then save the profile to a computer disk and recall as need. The user can then use the “Auto Program” feature to quickly program as many LED drivers with the saved profile as is required. Each driver programming simply requires a click of the mouse to program in a single step.

The YG Programmer software supports bar code scanners. The barcode scanner can be used to automate the programming of the attached LED driver. The barcodes scanner interface also provides an option to either enable or disable logging of the parameters to an excel file.

Note: The programming of the LED driver does not require the input be connected to an AC power connection. The YG Programmer and the required LED driver circuitry will be powered from the YG Programmer module via the USB connection to a computer.

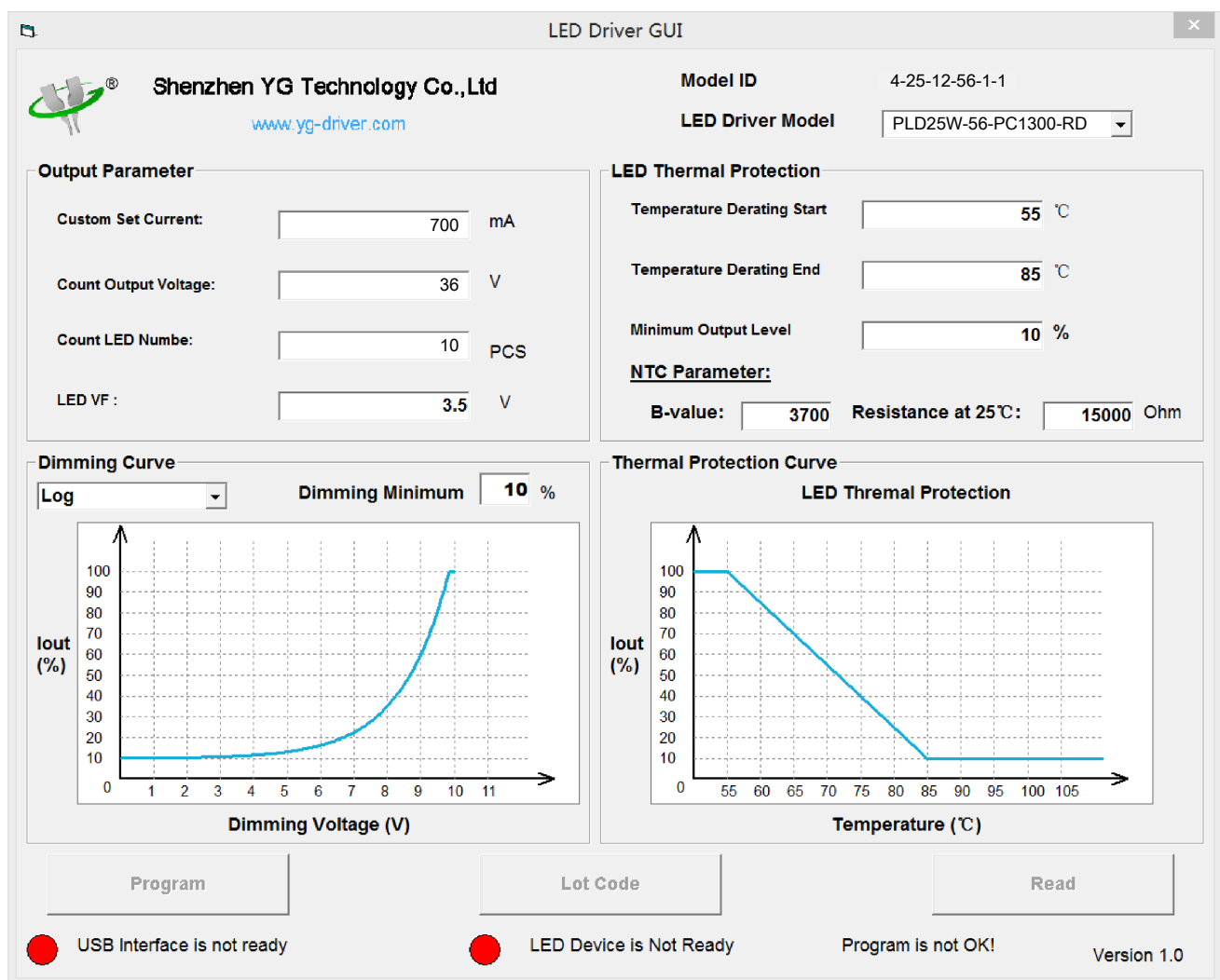

Custom designs available.

Please consult with the factory.

Specifications subject to change without notice.

Output Current Soft-start

Output current soft-start are programmable (enable/disable) features. The default mode for features is disabled for out-of-the-box products. If these features are required, they must be checked ON in the programming software.

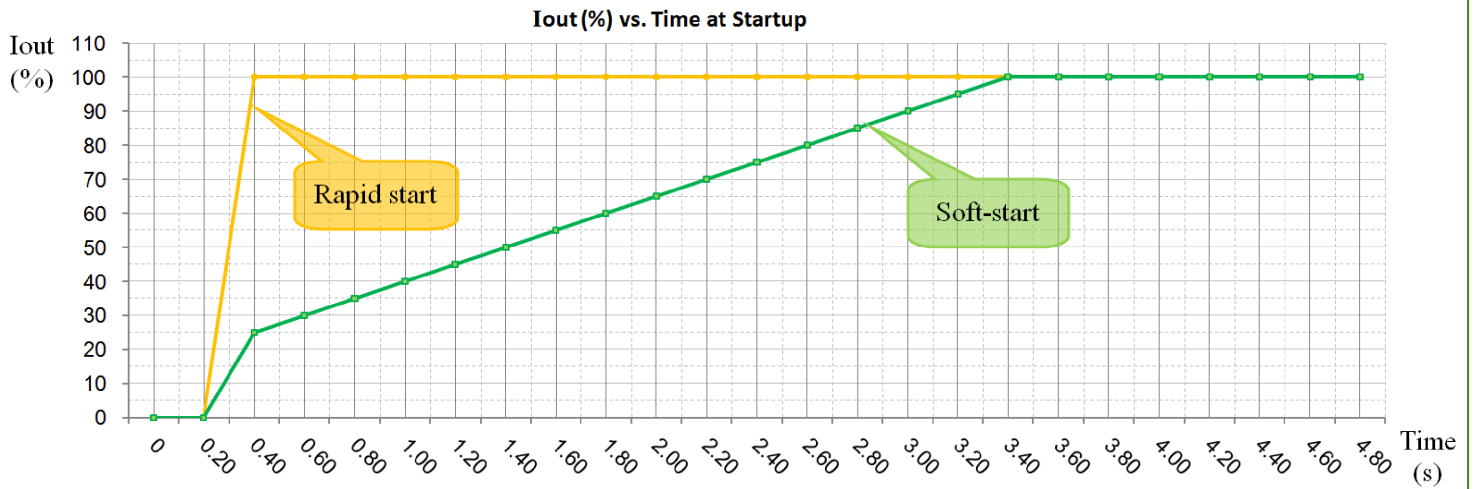

Constant Lumen Module

The Constant Lumen Module feature of the PLD25W helps to maintain the required lumen output of the fixture at a constant level throughout its lifetime. In general LED's lumen output will depreciate over time and in order to maintain sufficient light level towards the end of lifetime, the LED's are driven at high current initially and will result in more energy consumption. The constant lumen module will give the flexibility to drive the LEDs at optimal driving current throughout its lifetime. This helps in energy savings, constant light output and enhanced reliability of the system.

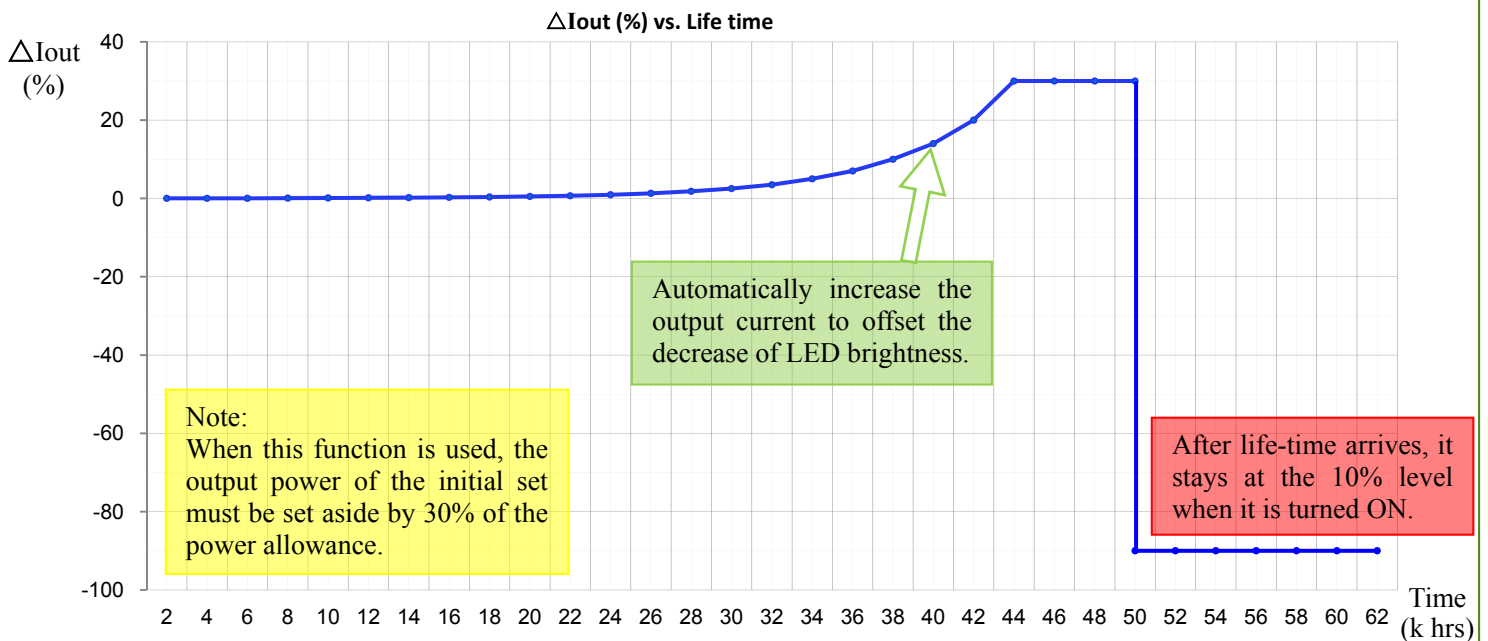

Note: A detailed step-by-step instructions are outlined in the Help section of the YG Programmer software.

End-of-Life Indicator

The End-of-Life indicator helps the end user to receive a signal from the fixture indicating that it has reached its programmed life-time. After the LED driver reaches the programmed life-time, whenever it is turned ON, it stays at 'Dim' level (10%).

Characteristic Curve

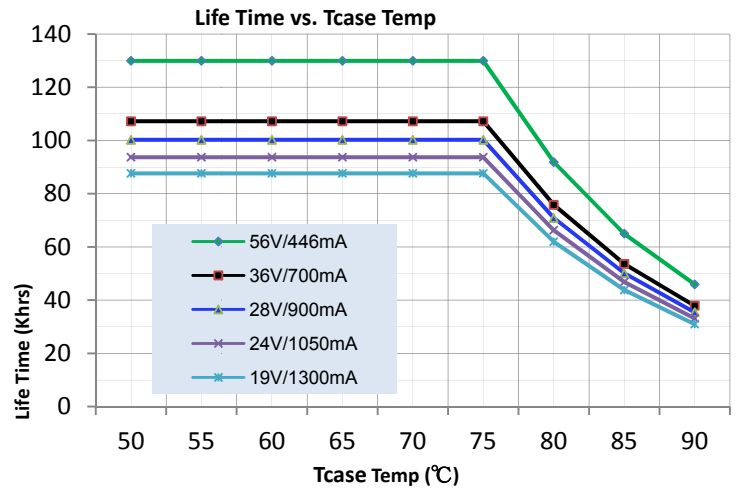
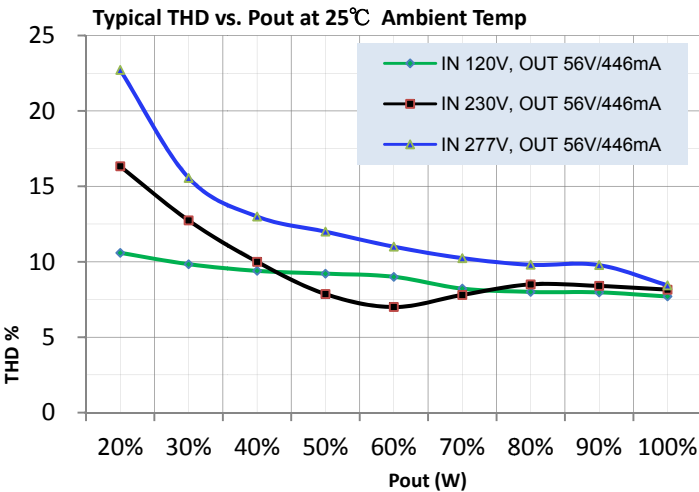
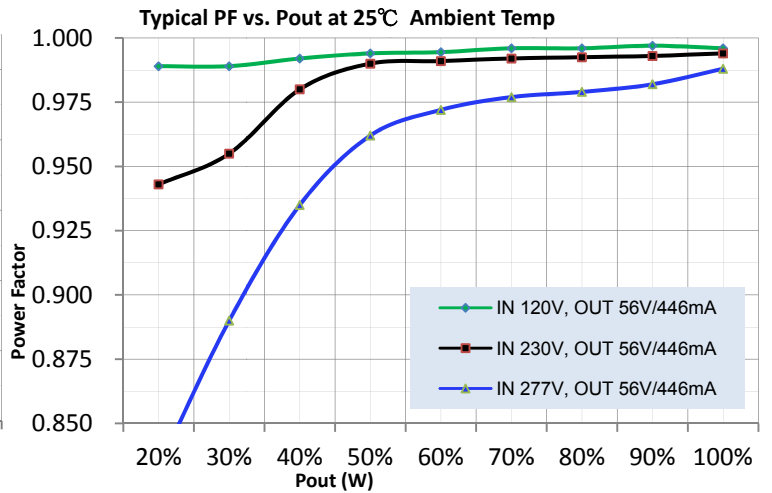
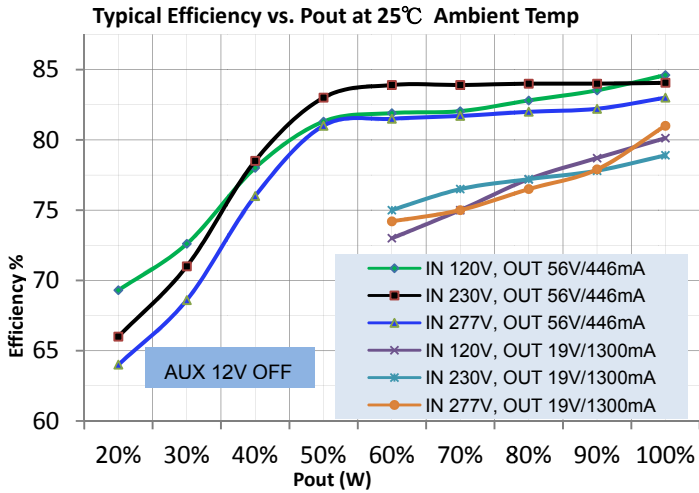

Programming Connection Diagram

Note the connection when programming

GUI_P+ (red) → NTC (gray)

GUI_P- (black) → SCOM (gray)

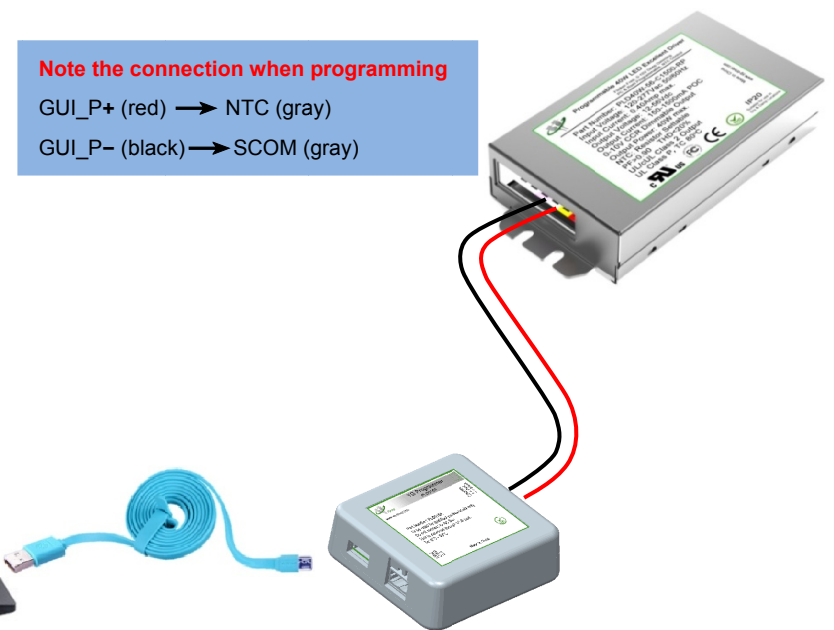

Installation

Metal shell;
 AC input for connection the WAGO-253-3P connectors;
 DC output for connection the WAGO-253-2P connectors;
 0-10V dimming input for the two WAGO-253-2P connectors;
 Other control for the WAGO-253-3P connectors;
 This product has two $\Phi 5.0\text{mm}$ mounting holes.

Order ID

P/N 1: PLD25W-56-C1300

Description: 25W, 56Vdc voltage max, constant current 1300mA max, constant current mode.

P/N 2: PLD25W-56-C1300-RP

Description: 25W, 56Vdc voltage max, constant current 1300mA max, 0-10V or PWM dimming mode.

Product Size

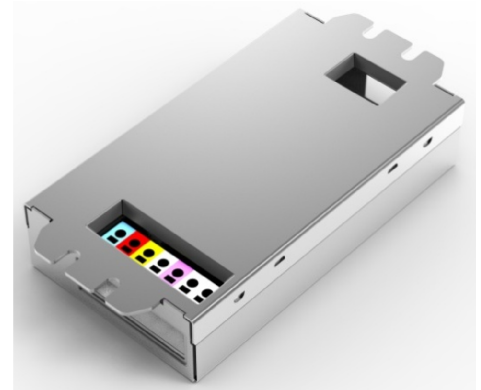
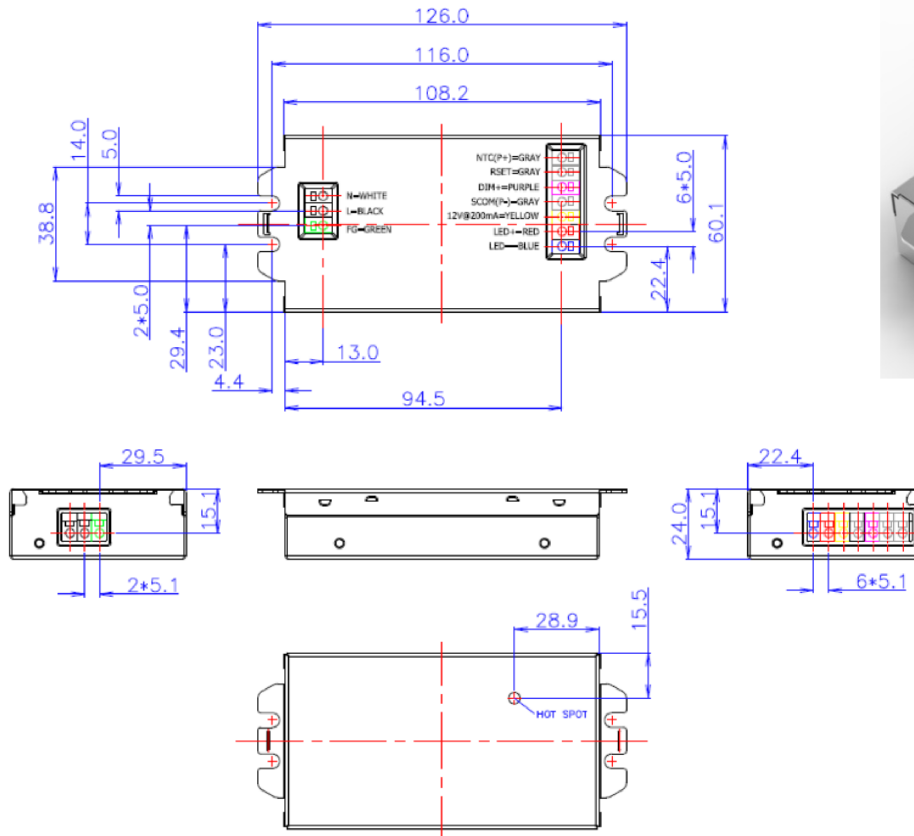

Note :

- The independent LED drive conforms to the EMC standard.
But it is not guaranteed to be qualified, when the drive is mounted in the LED lamp.
- Please forgive us for any discrepancy due to the update of the specifications or the upgrade of the product.
If you need the latest information, please contact our marketing department.